



# FDPF2710T

## 250V N-Channel PowerTrench MOSFET

### General Description

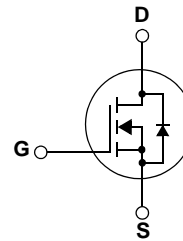
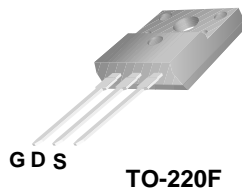
This N-Channel MOSFET is produced using Fairchild Semiconductor's advanced PowerTrench process that has been especially tailored to minimize the on-state resistance and yet maintain superior switching performance.

### Description

- 25A, 250V,  $R_{DS(on)} = 36.3m\Omega @ V_{GS} = 10V$
- Fast switching speed
- Low gate charge
- High performance trench technology for extremely low  $R_{DS(on)}$
- High power and current handling capability

### Application

- Ballast Application



### Absolute Maximum Ratings

Symbol	Parameter	Ratings	Unit
$V_{DS}$	Drain-Source Voltage	250	V
$V_{GS}$	Gate-Source voltage	$\pm 30$	V
$I_D$	Drain Current	- Continuous ( $T_C = 25^\circ C$ )	25
		- Continuous ( $T_C = 100^\circ C$ )	18.8
$I_{DM}$	Drain Current - Pulsed (Note 1)	100	A
$E_{AS}$	Single Pulsed Avalanche Energy (Note 2)	145	mJ
dv/dt	Peak Diode Recovery dv/dt (Note 3)	4.5	V/ns
$P_D$	Power Dissipation ( $T_C = 25^\circ C$ )	- Derate above $25^\circ C$	62.5
			0.5
$T_J, T_{STG}$	Operating and Storage Temperature Range	-55 to +150	$^\circ C$
$T_L$	Maximum Lead Temperature for Soldering Purpose, 1/8" from Case for 5 Seconds	300	$^\circ C$

### Thermal Characteristics

Symbol	Parameter	Min	Max	Unit
$R_{\theta JC}$	Thermal Resistance, Junction-to-Case	--	2.0	$^\circ C/W$
$R_{\theta JA}$	Thermal Resistance, Junction-to-Ambient	--	62.5	$^\circ C/W$

## Package Marking and Ordering Information

Device Marking	Device	Package	Reel Size	Tape Width	Quantity
FDPF2710T	FDPF2710T	TO-220F	--	--	50

## Electrical Characteristics T<sub>C</sub> = 25°C unless otherwise noted

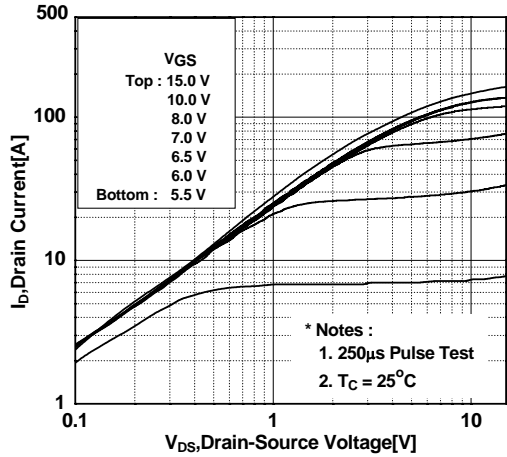
Symbol	Parameter	Conditions	Min	Typ	Max	Units
<b>Off Characteristics</b>						
BV <sub>DSS</sub>	Drain-Source Breakdown Voltage	V <sub>GS</sub> = 0V, I <sub>D</sub> = 250μA, T <sub>J</sub> = 25°C	250	--	--	V
ΔBV <sub>DSS</sub> / ΔT <sub>J</sub>	Breakdown Voltage Temperature Coefficient	I <sub>D</sub> = 250μA, Referenced to 25°C	--	0.25	--	V/°C
I <sub>DSS</sub>	Zero Gate Voltage Drain Current	V <sub>DS</sub> = 250V, V <sub>GS</sub> = 0V V <sub>DS</sub> = 250V, V <sub>GS</sub> = 0V, T <sub>C</sub> = 125°C	--	--	10 500	μA μA
I <sub>GSSF</sub>	Gate-Body Leakage Current, Forward	V <sub>GS</sub> = 30V, V <sub>DS</sub> = 0V	--	--	100	nA
I <sub>GSSR</sub>	Gate-Body Leakage Current, Reverse	V <sub>GS</sub> = -30V, V <sub>DS</sub> = 0V	--	--	-100	nA
<b>On Characteristics</b>						
V <sub>GS(th)</sub>	Gate Threshold Voltage	V <sub>DS</sub> = V <sub>GS</sub> , I <sub>D</sub> = 250μA	3.0	3.9	5.0	V
R <sub>DS(on)</sub>	Static Drain-Source On-Resistance	V <sub>GS</sub> = 10V, I <sub>D</sub> = 25A	--	36.3	42.5	mΩ
g <sub>FS</sub>	Forward Transconductance	V <sub>DS</sub> = 10V, I <sub>D</sub> = 25A (Note 4)	--	63	--	S
<b>Dynamic Characteristics</b>						
C <sub>iss</sub>	Input Capacitance	V <sub>DS</sub> = 25V, V <sub>GS</sub> = 0V, f = 1.0MHz	--	5470	7280	pF
C <sub>oss</sub>	Output Capacitance		--	426	567	pF
C <sub>rss</sub>	Reverse Transfer Capacitance		--	97	146	pF
<b>Switching Characteristics</b>						
t <sub>d(on)</sub>	Turn-On Delay Time	V <sub>DD</sub> = 125V, I <sub>D</sub> = 50A V <sub>GS</sub> = 10V, R <sub>GEN</sub> = 25Ω  (Note 4, 5)	--	80	170	ns
t <sub>r</sub>	Turn-On Rise Time		--	252	514	ns
t <sub>d(off)</sub>	Turn-Off Delay Time		--	112	234	ns
t <sub>f</sub>	Turn-Off Fall Time		--	154	318	ns
Q <sub>g</sub>	Total Gate Charge	V <sub>DS</sub> = 125V, I <sub>D</sub> = 50A V <sub>GS</sub> = 10V  (Note 4, 5)	--	78	101	nC
Q <sub>gs</sub>	Gate-Source Charge		--	34	--	nC
Q <sub>gd</sub>	Gate-Drain Charge		--	18	--	nC
<b>Drain-Source Diode Characteristics and Maximum Ratings</b>						
I <sub>S</sub>	Maximum Continuous Drain-Source Diode Forward Current		--	--	25	A
I <sub>SM</sub>	Maximum Pulsed Drain-Source Diode Forward Current		--	--	150	A
V <sub>SD</sub>	Drain-Source Diode Forward Voltage	V <sub>GS</sub> = 0V, I <sub>S</sub> = 25A	--	--	1.2	V
t <sub>rr</sub>	Reverse Recovery Time	V <sub>GS</sub> = 0V, I <sub>S</sub> = 50A di <sub>F</sub> /dt = 130A/μs (Note 4)	--	163	--	ns
Q <sub>rr</sub>	Reverse Recovery Charge		--	1.3	--	μC

### Notes:

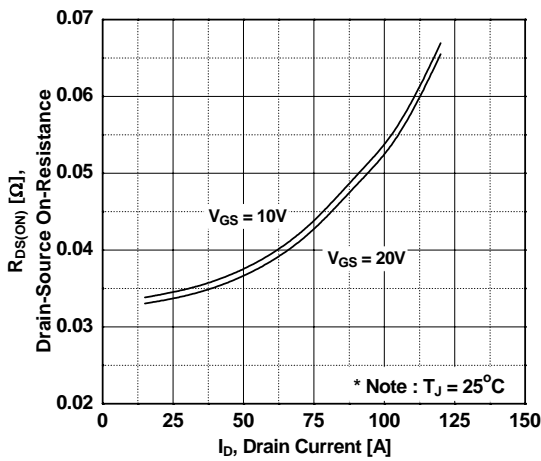
1. Repetitive Rating: Pulse width limited by maximum junction temperature
2. L = 1mH, I<sub>AS</sub> = 17A, V<sub>DD</sub> = 50V, R<sub>G</sub> = 25Ω, Starting T<sub>J</sub> = 25°C
3. I<sub>SD</sub> ≤ 50A, di/dt ≤ 200A/μs, V<sub>DD</sub> ≤ BV<sub>DSS</sub>, Starting T<sub>J</sub> = 25°C
4. Pulse Test: Pulse width ≤ 300μs, Duty Cycle ≤ 2%
5. Essentially Independent of Operating Temperature Typical Characteristics

## Typical Performance Characteristics

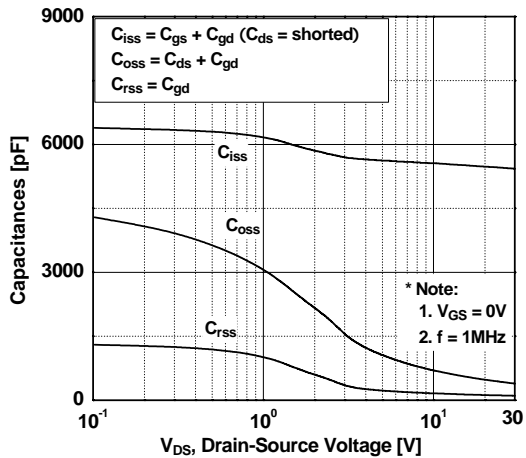
**Figure 1. On-Region Characteristics**



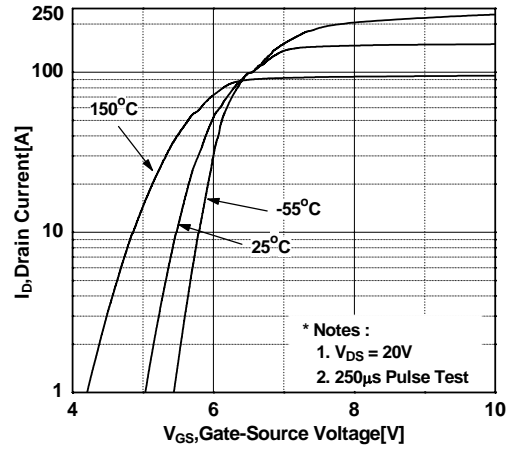
**Figure 3. On-Resistance Variation vs. Drain Current and Gate Voltage**



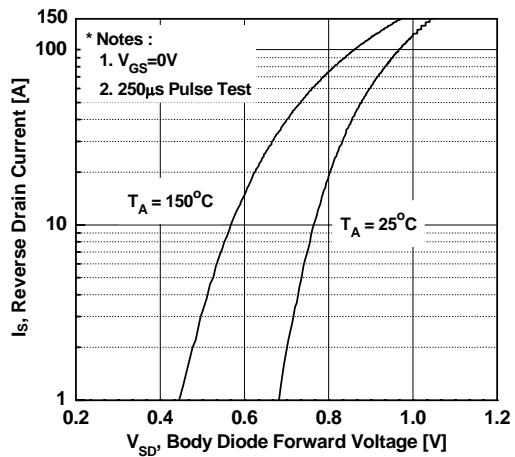
**Figure 5. Capacitance Characteristics**



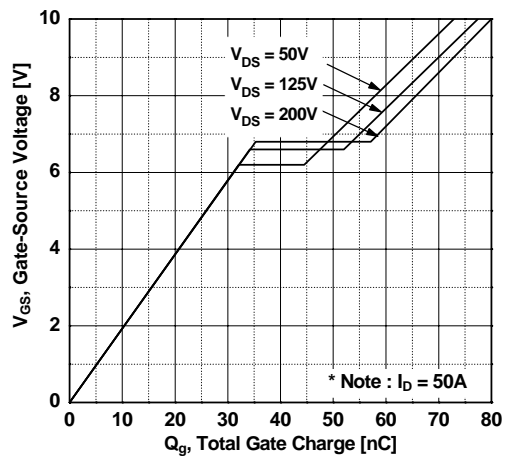
**Figure 2. Transfer Characteristics**



**Figure 4. Body Diode Forward Voltage Variation vs. Source Current and Temperature**

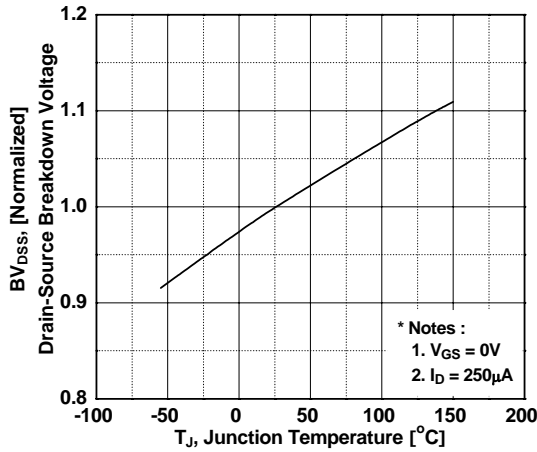


**Figure 6. Gate Charge Characteristics**

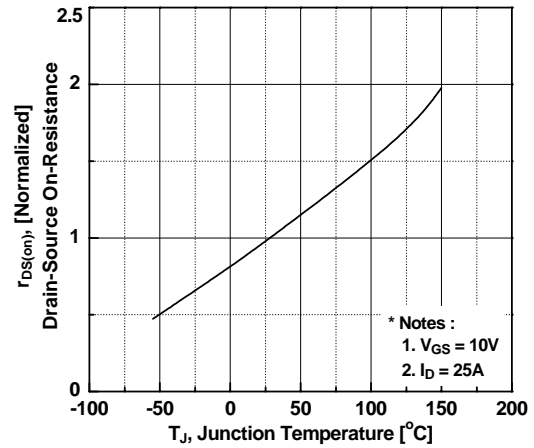


**Typical Performance Characteristics (Continued)**

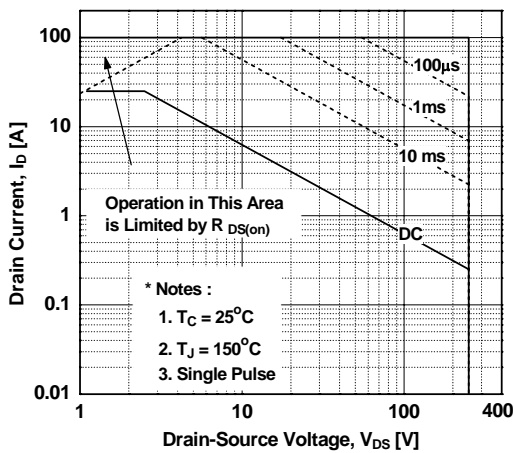
**Figure 7. Breakdown Voltage Variation vs. Temperature**



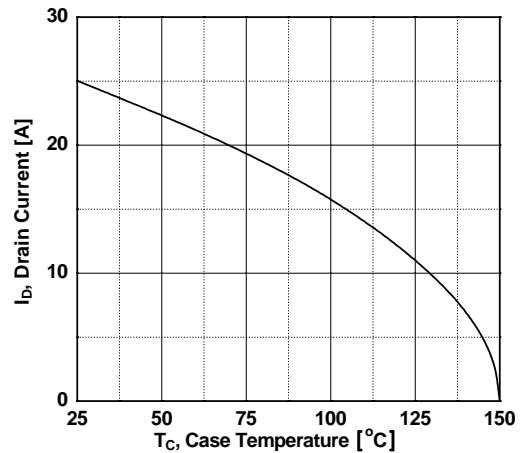
**Figure 8. On-Resistance Variation vs. Temperature**



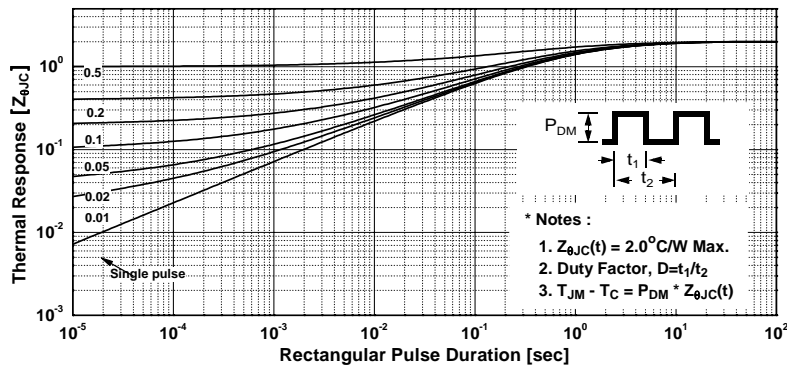
**Figure 9. Maximum Safe Operating Area**



**Figure 10. Maximum Drain Current vs. Case Temperature**



**Figure 11. Transient Thermal Response Curve**



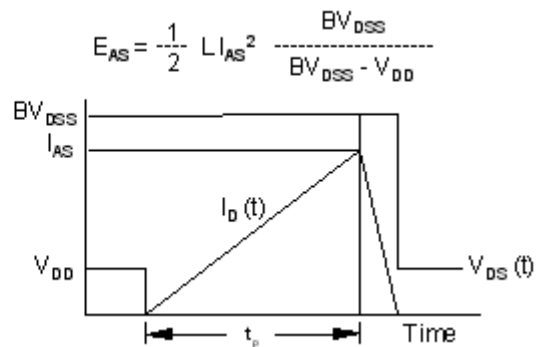
**Gate Charge Test Circuit & Waveform**



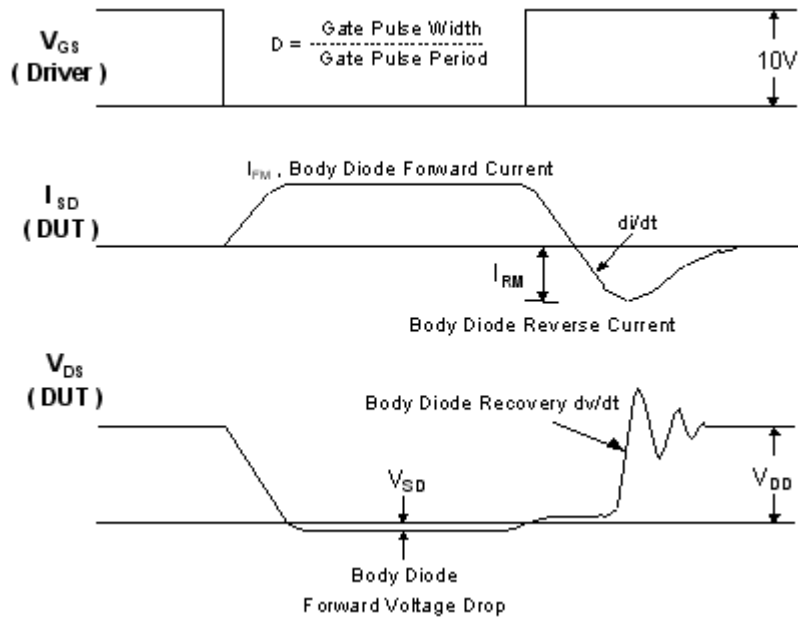
**Resistive Switching Test Circuit & Waveforms**



**Unclamped Inductive Switching Test Circuit & Waveforms**

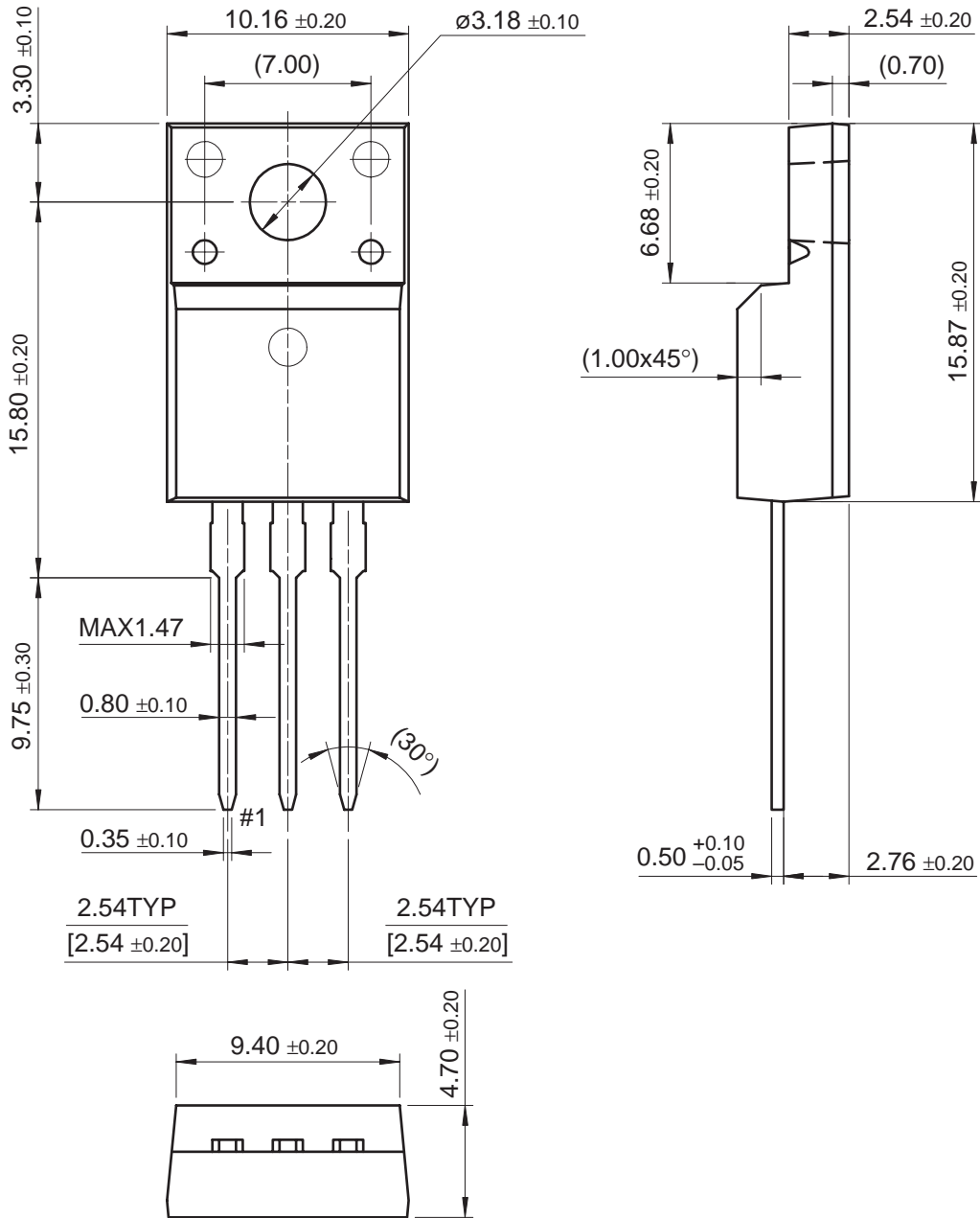


Peak Diode Recovery dv/dt Test Circuit & Waveforms



Mechanical Dimensions


TO-220F





### TRADEMARKS

The following are registered and unregistered trademarks and service marks Fairchild Semiconductor owns or is authorized to use and is not intended to be an exhaustive list of all such trademarks.

ACEx <sup>®</sup>	Green FPS <sup>™</sup>	Power247 <sup>®</sup>	SuperSOT <sup>™</sup> -8
Build it Now <sup>™</sup>	Green FPS <sup>™</sup> e-Series <sup>™</sup>	POWEREDGE <sup>®</sup>	SyncFET <sup>™</sup>
CorePLUS <sup>™</sup>	GTO <sup>™</sup>	Power-SPM <sup>™</sup>	The Power Franchise <sup>®</sup>
CROSSVOLT <sup>™</sup>	<i>i-Lo</i> <sup>™</sup>	PowerTrench <sup>®</sup>	<b>the power</b> franchise
CTL <sup>™</sup>	IntelliMAX <sup>™</sup>	Programmable Active Droop <sup>™</sup>	TinyBoost <sup>™</sup>
Current Transfer Logic <sup>™</sup>	ISOPLANAR <sup>™</sup>	QFET <sup>®</sup>	TinyBuck <sup>™</sup>
EcoSPARK <sup>®</sup>	MegaBuck <sup>™</sup>	QST <sup>™</sup>	TinyLogic <sup>®</sup>
<b>F</b> <sup>®</sup>	MICROCOUPLER <sup>™</sup>	QT Optoelectronics <sup>™</sup>	TINYOPTO <sup>™</sup>
Fairchild <sup>®</sup>	MicroFET <sup>™</sup>	Quiet Series <sup>™</sup>	TinyPower <sup>™</sup>
Fairchild Semiconductor <sup>®</sup>	MicroPak <sup>™</sup>	RapidConfigure <sup>™</sup>	TinyPWM <sup>™</sup>
FACT Quiet Series <sup>™</sup>	MillerDrive <sup>™</sup>	SMART START <sup>™</sup>	TinyWire <sup>™</sup>
FACT <sup>®</sup>	Motion-SPM <sup>™</sup>	SPM <sup>®</sup>	μSerDes <sup>™</sup>
FAST <sup>®</sup>	OPTOLOGIC <sup>®</sup>	STEALTH <sup>™</sup>	UHC <sup>®</sup>
FastvCore <sup>™</sup>	OPTOPLANAR <sup>®</sup>	SuperFET <sup>™</sup>	UniFET <sup>™</sup>
FPS <sup>™</sup>	 <sup>®</sup>	SuperSOT <sup>™</sup> -3	VCX <sup>™</sup>
FRFET <sup>®</sup>	PDP-SPM <sup>™</sup>	SuperSOT <sup>™</sup> -6	
Global Power Resource <sup>SM</sup>	Power220 <sup>®</sup>		

### DISCLAIMER

FAIRCHILD SEMICONDUCTOR RESERVES THE RIGHT TO MAKE CHANGES WITHOUT FURTHER NOTICE TO ANY PRODUCTS HEREIN TO IMPROVE RELIABILITY, FUNCTION, OR DESIGN. FAIRCHILD DOES NOT ASSUME ANY LIABILITY ARISING OUT OF THE APPLICATION OR USE OF ANY PRODUCT OR CIRCUIT DESCRIBED HEREIN; NEITHER DOES IT CONVEY ANY LICENSE UNDER ITS PATENT RIGHTS, NOR THE RIGHTS OF OTHERS. THESE SPECIFICATIONS DO NOT EXPAND THE TERMS OF FAIRCHILD'S WORLDWIDE TERMS AND CONDITIONS, SPECIFICALLY THE WARRANTY THEREIN, WHICH COVERS THESE PRODUCTS.

### LIFE SUPPORT POLICY

FAIRCHILD'S PRODUCTS ARE NOT AUTHORIZED FOR USE AS CRITICAL COMPONENTS IN LIFE SUPPORT DEVICES OR SYSTEMS WITHOUT THE EXPRESS WRITTEN APPROVAL OF FAIRCHILD SEMICONDUCTOR CORPORATION.

As used herein:

- Life support devices or systems are devices or systems which, (a) are intended for surgical implant into the body or (b) support or sustain life, and (c) whose failure to perform when properly used in accordance with instructions for use provided in the labeling, can be reasonably expected to result in a significant injury to the user.
- A critical component in any component of a life support, device, or system whose failure to perform can be reasonably expected to cause the failure of the life support device or system, or to affect its safety or effectiveness.

### PRODUCT STATUS DEFINITIONS

#### Definition of Terms

Datasheet Identification	Product Status	Definition
Advance Information	Formative or In Design	This datasheet contains the design specifications for product development. Specifications may change in any manner without notice.
Preliminary	First Production	This datasheet contains preliminary data; supplementary data will be published at a later date. Fairchild Semiconductor reserves the right to make changes at any time without notice to improve design.
No Identification Needed	Full Production	This datasheet contains final specifications. Fairchild Semiconductor reserves the right to make changes at any time without notice to improve design.
Obsolete	Not In Production	This datasheet contains specifications on a product that has been discontinued by Fairchild Semiconductor. The datasheet is printed for reference information only.

Rev. I31